



Republic of the Philippines
SOUTHERN LUZON STATE UNIVERSITY
Lucban, Quezon



REQUEST FOR QUOTATION

UPGRADING AND IMPROVEMENT OF CAM AUDITORIUM PHASE 2 (PMO)

Purchase Request No. 2026-03-0924

Approved Budget for the Contract: ₱ 1,950,000.00

The Southern Luzon State University through the Bids and Awards Committee invites interested firms/supplier to submit quotation for the procurement of **Upgrading and Improvement of CAM Auditorium Phase 2 (PMO)** to apply the sum of **One Million and Nine Hundred Fifty Thousand Pesos Only (₱ 1,950,000.00)** inclusive of VAT, being the **Approved Budget for the Contract (ABC)**, details as follows:

Qty.	Unit	ITEM/S DESCRIPTION
		LOT 1
1	lot	Supply & Installation of Auditorium Chairs
		LOT 2
1	lot	Supply and Installation of Sound System

1. The quotation must be submitted (can also be sent thru email at the contact details listed below) or to the Office of the Procurement Office/Bids and Awards Committee, Southern Luzon State University, 2nd Flr. Hermano Puli Building, and shall be received by the Committee.

E-mail : slsuprocedurement@slsu.edu.ph

2. The SLSU reserves the right to reject any or all quotations and/or proposals and waive any formalities/ informalities therein and to accept such bids it may consider as most advantageous to the agency and to the government. Southern Luzon State University SLSU neither assumes any obligation for whatsoever losses that may be incurred in the preparation of bids, nor does it guarantee that an award will be made.

MARIDEL C. ZABELLA
Director, Procurement Office
Southern Luzon State University
Lucban, Quezon
Tel. No.: (042)540-6519

Republic of the Philippines
Southern Luzon State University
Project Management Office
Lucban, Quezon

PROJECT TITLE: Upgrading of College of Allied Medicine Auditorium (Phase II)
PROJECT LOCATION: Brgy. Kulapi SLSU Main Campus Lucban Quezon
OWNER: Southern Luzon State University
PROJECT DURATION: 120 CD
SUBJECT: Minimum Technical Personnel and Equipment

MINIMUM TECHNICAL PERSONNEL AND EQUIPMENT

QUANTITY	MINIMUM TECHNICAL PERSONNEL
1	Foreman
2	Skilled Worker
2	Unskilled Worker

QUANTITY	MINIMUM EQUIPMENT
1	Electric Drill
1	Electric Grinder

Prepared by:

Engr. Joe Marino P. Abutal
Assistant Planning Engineer

Reviewed by:

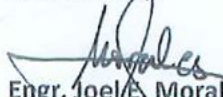
Engr. Joel E. Morales
Project Development Officer-1

Recommending Approval:

Engr. Melvin A. Malipagay
Director-Project Management Office

Approved by:

Dr. Frederick T. Villa
University President

Republic of the Philippines
Southern Luzon State University
Project Management Office
Lucban, Quezon

PROJECT TITLE : Upgrading of College of Allied Medicine Auditorium (Phase II)
PROJECT LOCATION : Brgy. Kulapi, Lucban Quezon
OWNER : Southern Luzon State University
PROJECT DURATION : 120 CD
SUBJECT : Scope of works/ Specifications

SCOPE OF WORKS/SPECIFICATIONS

I. GENERAL REQUIREMENTS

- Mobilization – Mobilization shall include all activities and associated cost for transportation of contractor’s personnel, equipment and material supplies to the site.
- Demobilization – Demobilization shall include all activities and cost for transportation of personnel, equipment and supplies not required or included in the contract from the site; including disassembly, removal and site clean-up of facilities assembled at the site.
- Safety & health program - This shall include the labor cost of first aider and material cost that will be used for construction, such as safety shoes, safety helmet, first aid kit/meds, and specialized PPE in the duration of the project including DOLE application.

II. AUDITORIUM CHAIRS

- This item shall consist of supply and installation of auditorium chairs including all of it’s accessories.
- The auditorium chairs will be subject for approval by the authorize representative of the University before installation.

III. SOUND SYSTEM

- This item shall consist of supply and installation of sound system for the auditorium.
- Cables and testing/commissioning are included in this item of works.
- Restoration of sound proof panels and structures affected by the installation of sound system are also included in this scope of work.
- The items for installation will be subject for approval by the authorize representative of the University.

Prepared by:

Engr. Joe Marino P. Abutal
Assistant Planning Engineer

Reviewed by:

Engr. Joel E. Morales
Project Development Officer-1

Recommending Approval:

Engr. Melvin A. Makipagay
Director, Project Management Office

Approved by:

Dr. Frederick T. Villa
University President

Project : Upgrading of College of Allied Medicine Auditorium (Phase II)
 Location Brgy. Kulapi, Lucban Quezon
 Owner : Southern Luzon State University
 Mode of Implementation : by Contract
 Project Duration : 120 Calendar Days

GANNT CHART/CONSTRUCTION SCHEDULE

Item	Description	Duration (days)	Duration (Days)																	
			7	14	21	28	35	42	49	56	63	70	77	84	91	98	105	112	120	
I	GENERAL REQUIREMENTS																			
	Mobilization	7																		
	Safety & Health Program	120																		
	Demobilization	7																		
II	AUDITORIUM CHAIRS																			
	Installation of Auditorium Chairs (Incl. Delivery)	60																		
III	SOUND SYSTEM (AUDITORIUM)																			
	Installation of Sound System	60																		

Prepared by:

JOEL MORALES
ENGR. JOE MARINO P. ABUTAL
 Assistant Planning Engineer

Reviewed by:

JOEL MORALES
ENGR. JOEL MORALES
 PDC-1

Recommending Approval :

MELVIN M. KIPAGAY
ENGR. MELVIN M. KIPAGAY
 Director - PMO

Approved By:

FREDERICK T. VILLA
DR. FREDERICK T. VILLA
 University President

Republic of the Philippines
SOUTHERN LUZON STATE UNIVERSITY
Project Management Office
Lucban, Quezon

PROJECT TITLE : Upgrading of College of Allied Medicine Auditorium (Phase II)
PROJECT LOCATION : Brgy. Kulapi, Lucban Quezon
OWNER : Southern Luzon State University
ABC : P 1,398,265.78
PROJECT DURATION : 120 CD
PROJECT BRIEF DESCRIPTION : Supply and Installation of Auditorium Chairs

INFRA 

SUMMARY

ITEM	DESCRIPTION	COST OF MATERIALS	COST OF LABOR AND EQUIPMENT	TOTAL
1.0	Supply and Installation of Auditorium Chairs			

Amount in Words :

Name of Bidder :



**COST ESTIMATES
(IN PESOS)**

Name of Project : **Upgrading of College of Allied Medicine Auditorium (Phase II)**
 Location : **Brgy. Kulapi, Lucban, Quezon**

ITEM NO.	Name of Item :	Quantity	Unit			
1.0	Supply and Installation of Auditorium Chairs	1.00	lot			
Materials	PRICE NO.	NAME AND SPECIFICATION OF MATERIALS	QTY.	UNIT	UNIT RATE	COST
	1	Mobilization/Demobilization	1.00	lot		
	2	Safety & Health Program	1.00	lot		
	3	Auditorium Chairs (Foldable with desk)	110	set/s		
	4	Consumables (Bolts/Nuts/Washer, Drill Bits, etc.)	1.00	lot		
TOTAL FOR MATERIALS						
SEQUENCE OF OPERATIONS:						
Equipment	NAME, CAPACITY & HP RATING OF EQUIPMENT	NO. OF UNITS	NO. OF HOURS	HOURLY RATE		
TOTAL FOR EQUIPMENT						
Labor	DESIGNATION OF PERSONNEL	NO.	NO. OF HOURS	HOURLY RATE		
	1 Foreman					
	2 Auditorium Chair Installers					
	3 Labor					
TOTAL FOR LABOR						
WORK DAYS TO COMPLETE		ESTIMATED DIRECT COST				
		OVERHEAD, CONTINGENCIES & MISC.				
CALENDAR DAYS TO COMPLETE		CONTRACTOR'S PROFIT				
		VALUE ADDED TAX				
		TOTAL COST				

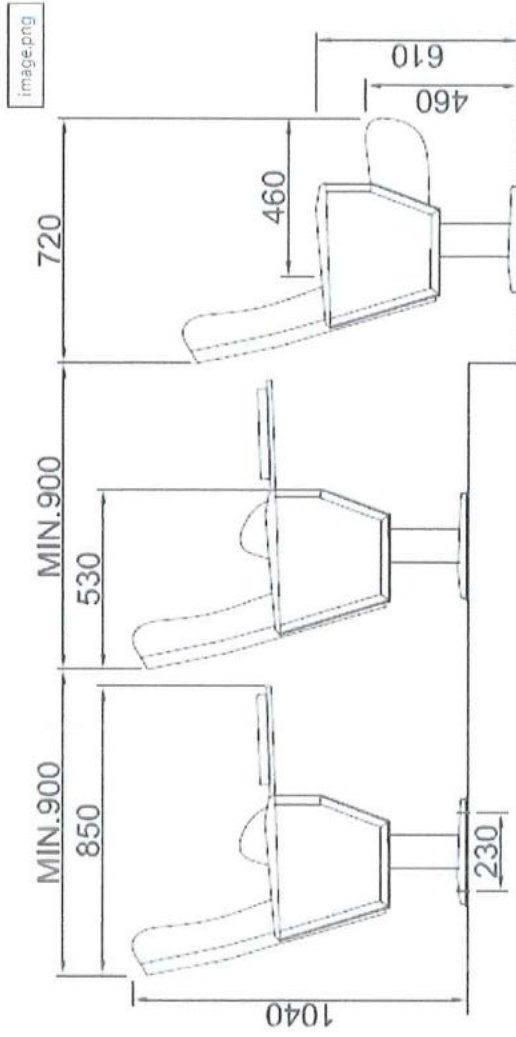
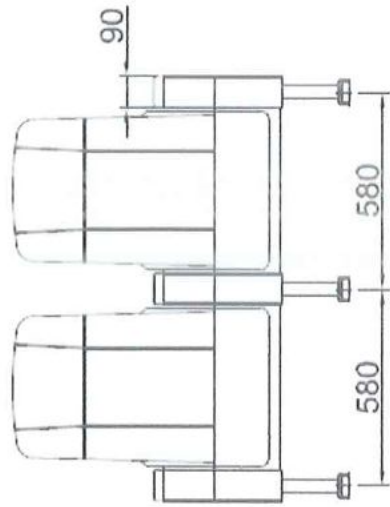
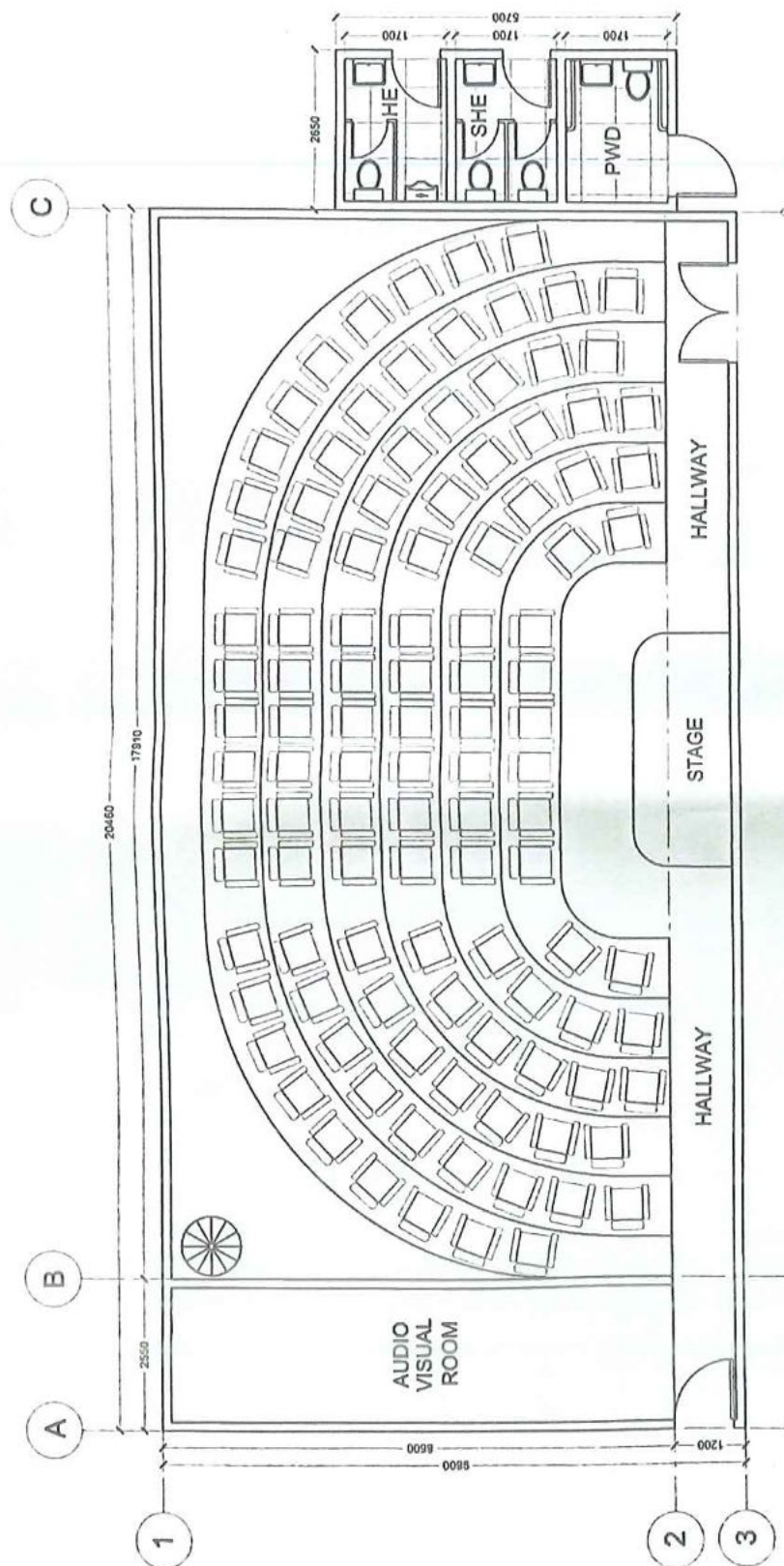







image.png





1 FLOOR PLAN
A-2 SCALE 1:80

 CIVIL STRUCTURAL ENGINEER No. 12345 State of California	PROJECT TITLE: UPGRADING OF COLLEGE OF ALLIED MEDICINE AUDITORIUM (PHASE II) <small>ADDRESS: 1234 MAIN STREET, DUBLIN, CALIFORNIA, 94568</small>	DRAWN BY:  ENGR. JOE MARINO P. ABUTIL <small>REGISTERED PROFESSIONAL ENGINEER No. 12345 State of California</small>	REVIEWED BY:  ENGR. JOSE MORALES <small>REGISTERED PROFESSIONAL ENGINEER No. 12345 State of California</small>	RECOMMENDING APPROVAL:  ENGR. MELVIN MAGAY <small>ENR. CIVIL PROJECT MANAGER OFFICE No. 12345 State of California</small>	APPROVED BY:  DR. FREDERICK T. VILLA <small>PROFESSOR No. 12345 State of California</small>	SHEET CONTENT: FLOOR PLAN	SHEET #: A-2
	PROJECT LOCATION: COLLEGE OF ALLIED MEDICINE AUDITORIUM, DUBLIN, CALIFORNIA						



- DIMENSI

Republic of the Philippines
SOUTHERN LUZON STATE UNIVERSITY
Project Management Office
Lucban , Quezon

PROJECT TITLE : Upgrading of College of Allied Medicine Auditorium (Phase II)
PROJECT LOCATION : Brgy. Kulapi, Lucban Quezon
OWNER : Southern Luzon State University
ABC : P 551,734.22
PROJECT DURATION : 120 CD
PROJECT BRIEF DESCRIPTION : Supply and Installation of Sound System

INFRA 

SUMMARY

ITEM	DESCRIPTION	COST OF MATERIALS	COST OF LABOR AND EQUIPMENT	TOTAL
2.0	Supply and Installation of Sound System			

Amount in Words :

Name of Bidder :



COST ESTIMATES
(IN PESOS)

Name of Project : Upgrading of College of Allied Medicine Auditorium (Phase II)

Location : Brgy. Kulapi, Lucban, Quezon

ITEM NO.	Name of Item :	Quantity	Unit	UNIT RATE	COST
2.0	Supply and Installation of Sound System	1.00	lot		
	PRICE	QTY.	UNIT	UNIT RATE	COST
	NO.				
	NAME AND SPECIFICATION OF MATERIALS				
1	Mobilization/Demobilization	1.00	lot		
2	Safety & Health Program	1.00	lot		
3	System Type 5" 2-way Passive System Output Power 120W (CONTINUOUS) 240W (PROGRAM) Sensitivity (1W/1M) 95dB, Maximum SPL @ 1m 115,5dB Max. (calculated), Frequency Response 90Hz-20kHz (-10dB) Impedance 16 ohms Transducer Low 2 x 5" Woofer, 1,18" (30mm) Voice Coil Transducer High 1 x 1" Tweeter, 1" (25mm) Voice Coil	12.00	unit/s		
4	System Type: Active Subwoofer Speaker Cabinet, Transducer Low: 12" Woofer - 3" Voice Coil Output Power: 1000, Continuous / 2000W Program / 4000W Peak Power, Class D, Max SPL: 129dB	1.00	unit/s		
5	500 Watts X 4 RMS @ 4 Ohms, 250 Watts X 4 RMS @ 8 Ohms	1.00	unit/s		
6	22 Inputs, 16XLR's/4Line, 2 USB 12 Outputs/Buses ,2HD FX Processors 32 DSP Channels Gate/PEQ/Compressor,6DCA Groups Physical Metering & Software Meters , iPad Remote Control Easy install Matrix	1.00	unit/s		
7	Dual Wireless Microphone PLL UHF Synthesized System 101 Frequencies per Channel LCD Display, Intelligent Recognition & ID Lock	2.00	set/s		
8	Built-in DSP Speaker configuration: 8" woofer with 1.5" voice coil and 1" neodymium compression driver Power: 300 W RMS, 600 W peak, Max SPL: 122 d	2.00	unit/s		
9	Flybar for Swift 25	3.00	unit/s		
TOTAL FOR MATERIALS					
SEQUENCE OF OPERATIONS:					
Equipment	NAME, CAPACITY & HP RATING OF EQUIPMENT	NO. OF UNITS	NO. OF HOURS	HOURLY RATE	
TOTAL FOR EQUIPMENT					
Labor	DESIGNATION OF PERSONNEL	NO.	NO. OF HOURS	HOURLY RATE	
	1 Foreman				
	2 Sound System Technician/Installers				
	3 Labor				
TOTAL FOR LABOR					
WORK DAYS TO COMPLETE		ESTIMATED DIRECT COST			
		OVERHEAD, CONTINGENCIES & MISC.			
CALENDAR DAYS TO COMPLETE		CONTRACTOR'S PROFIT			
		VALUE ADDED TAX			
		TOTAL COST			